

InterLAN-EI.820C-T

EASY-I.820C-T

Dispositivo ASBIS (SMU), di tipo industriale, per la gestione dei sistemi di interfonia Over IP in conformità alla norma EN62820

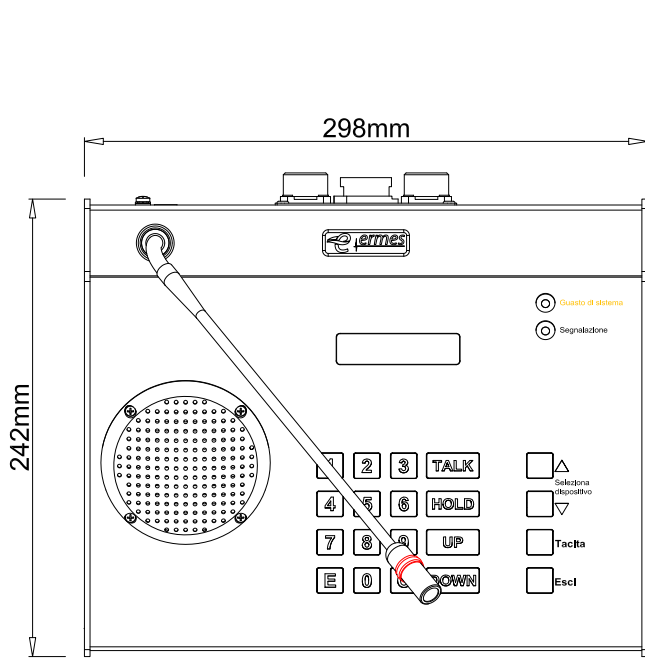

Dimensioni

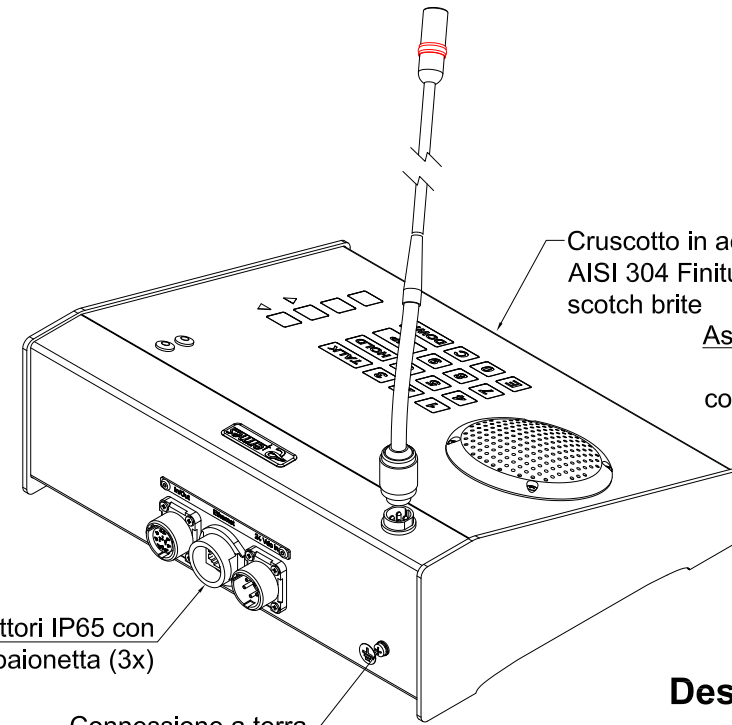
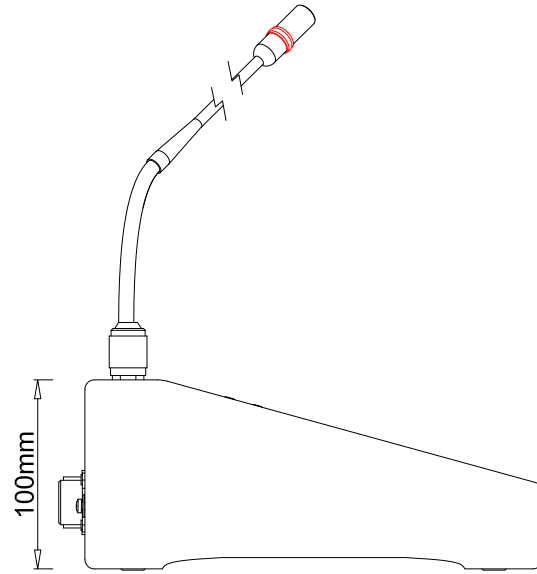

Descrizione

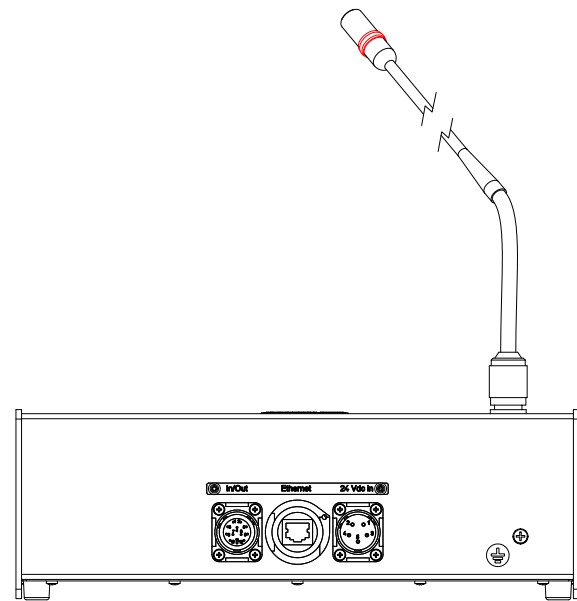
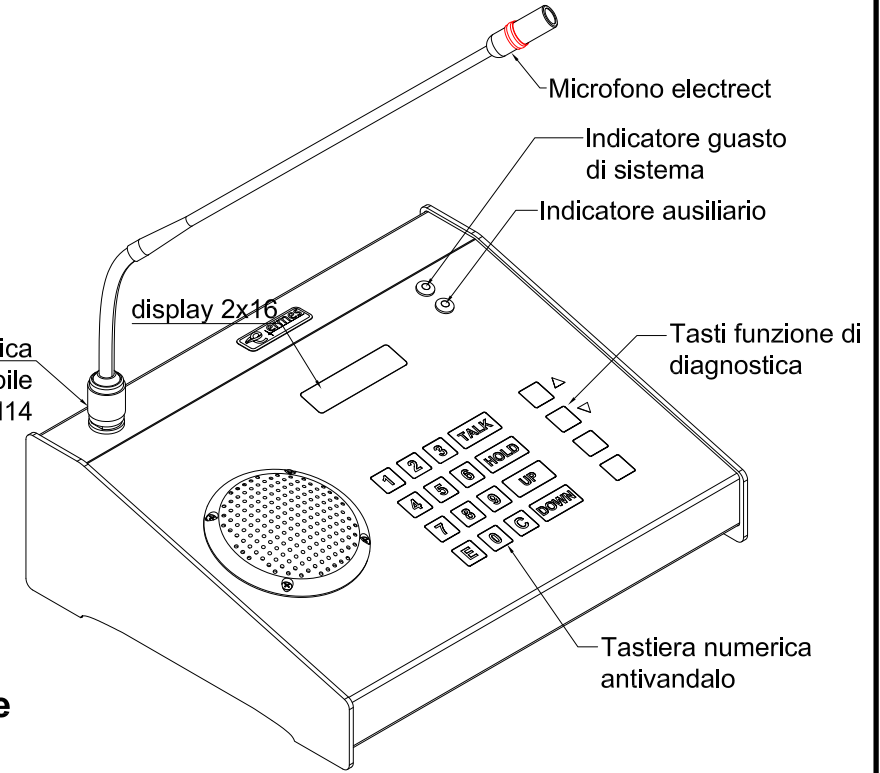

Connessioni



In/Out 12 female socket	
1	In 1a
2	In 1b
3	In 2a
4	In 2b
5	Out 1a
6	Out 1b
7	Out 2a
8	Out 2b
9	Reserved
10	Reserved
11	Reserved
12	Reserved

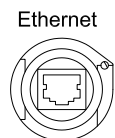

Ethernet RJ45 E820C3 (10/100Base-T)	Wire
1	White/orange
2	Orange
3	White/green
4	Blue
5	White/Blue
6	Green
7	White/Brown
8	Brown

SFTP CAT5e ethernet cable (or upper) (4x2x2xAVMG22 RJ45)



24 Vdc in 5 male socket	Wire
1	+24V@10W 1x1,5
2	0V 1x1,5
3	reserved
4	reserved
5	earth 1x1,5

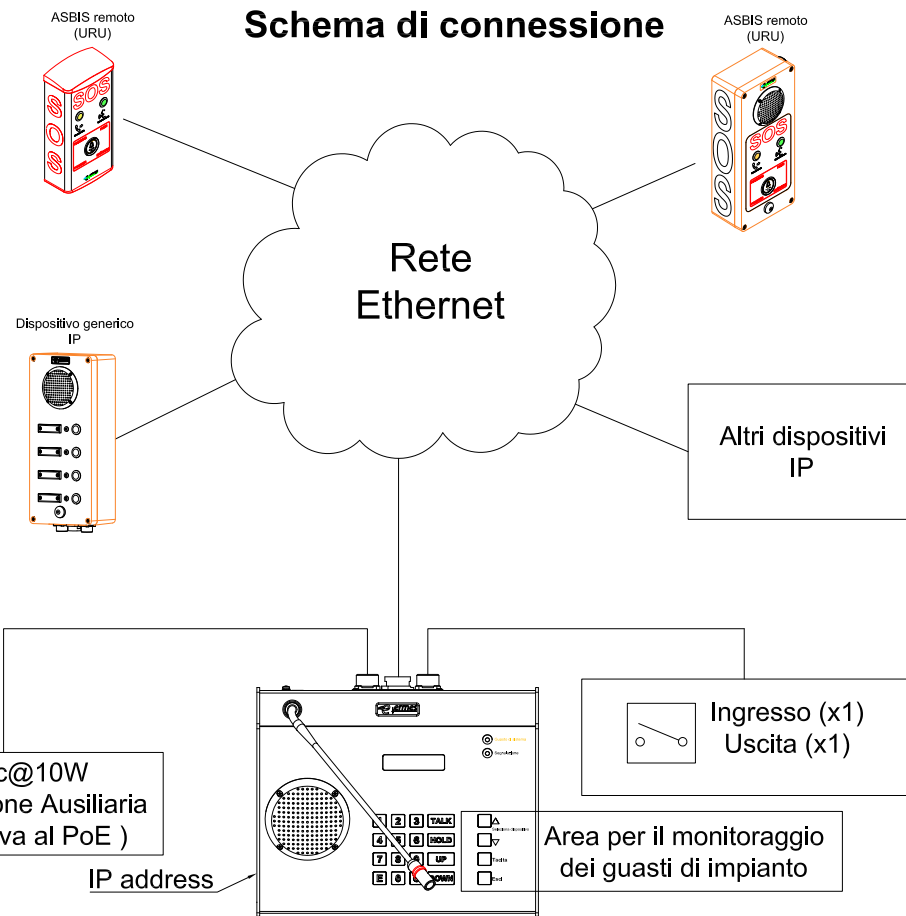

Schema di connessione